

zonder voetstuk (op maat gemaakt door eindgebruiker)
without base (custom-made by end-user)

* = optional air inlet \varnothing 125 mm
** = height INCL optional air inlet
*** = height EXCL optional air inlet

barbas

Barbas Bellfires B.V.
Hallenstraat 17
5531 AB Bladel
The Netherlands
www.barbasbellfires.com

Name: **BOX²⁵ 55**

Modifications reserved

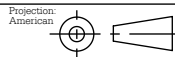

Scale: **1:15**
Unit: **mm**

Version: **0**

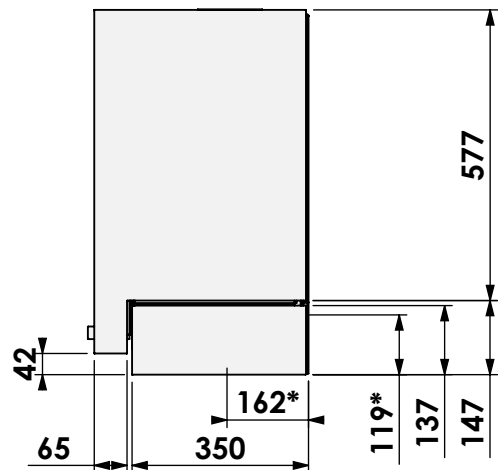
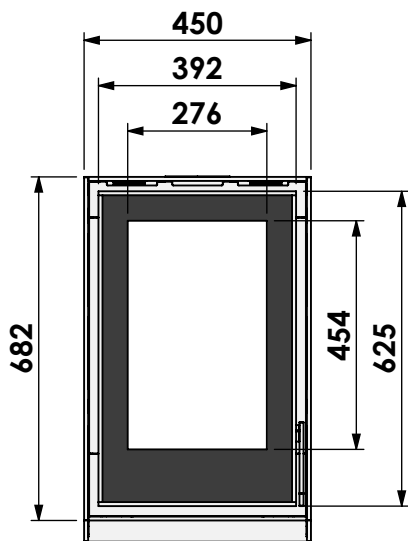
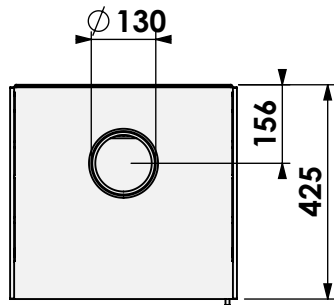

stalen voetstuk
steelbase

* = optional air inlet \varnothing 125 mm

barbas

Barbas Bellfires B.V.
Hallenstraat 17
5531 AB Bladel
The Netherlands
www.barbasbellfires.com

Name: **BOX²⁵ 55**

Modifications reserved

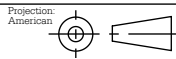

Scale: **1:15**
Unit: **mm**

Version: **0**

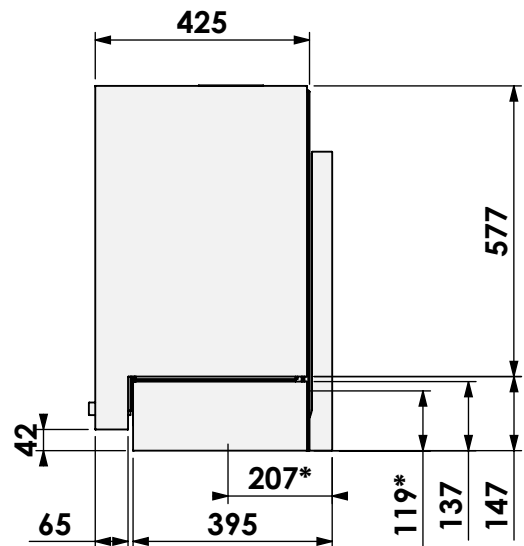
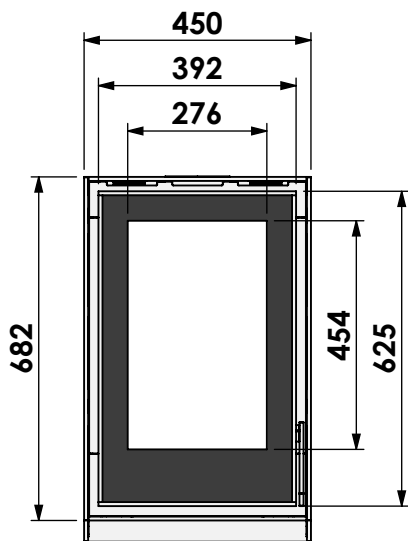
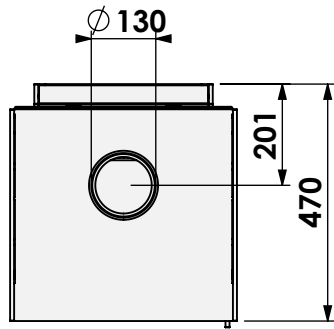

hanghaard
hanging

* = optional air inlet \varnothing 125 mm

barbas

Barbas Bellfires B.V.
Hallenstraat 17
5531 AB Bladel
The Netherlands
www.barbasbellfires.com

Name: **BOX²⁵ 55**

Modifications reserved

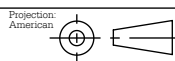

Scale: **1:15**
Unit: **mm**

Version: **0**

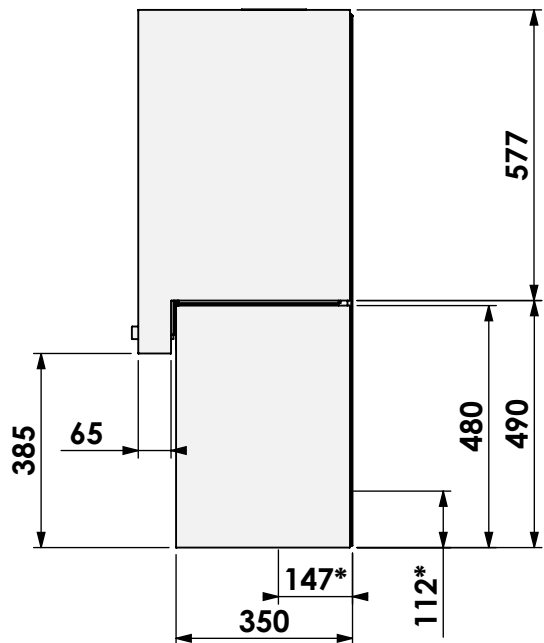
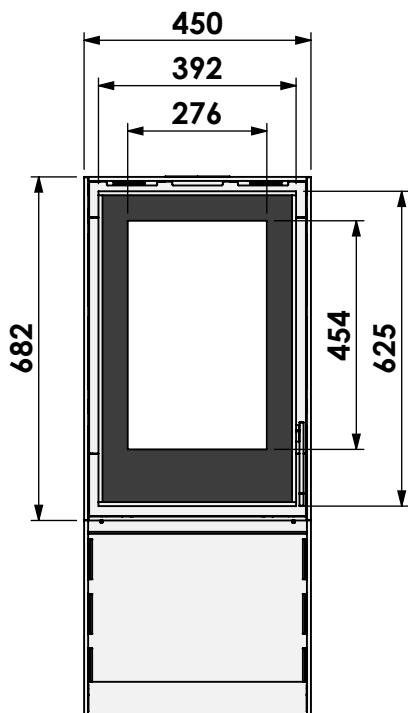
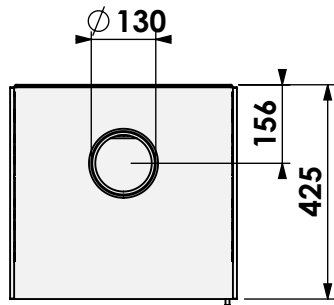

houtopslagmodule
wood log storage module

* = optional air inlet \varnothing 125 mm

barbas

Barbas Bellfires B.V.
Hallenstraat 17
5531 AB Bladel
The Netherlands
www.barbasbellfires.com

Name: **BOX²⁵ 55**

Modifications reserved

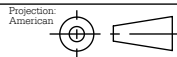

Scale: **1:15**
Unit: **mm**

Version: **0**